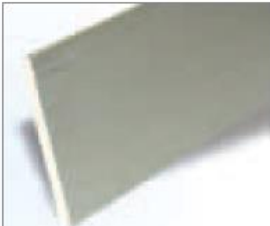
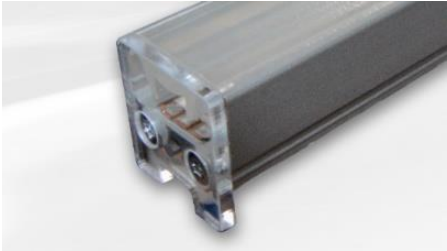
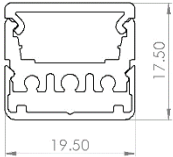
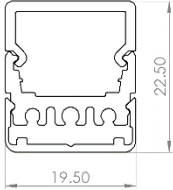
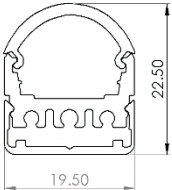
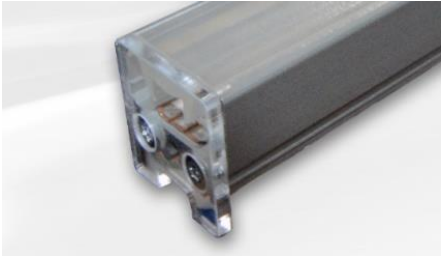
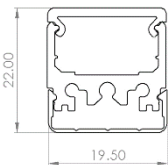
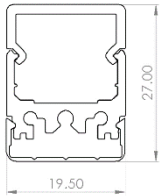
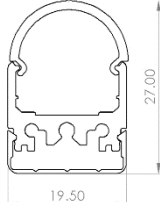

Integrate

Aluminium Profiles

Surface Mounted or Suspended

<p>1</p>  <p>2mm x 15mm, 20mm, 25mm wide (for use with LED up to 15w/m)</p>	 <p>2 mm x 25 mm</p>
<p>2</p>  <p>19.5mm wide x (other dimensions as drawing) Surface mounted Direct only IP40, IP44 Round, Low & High Square cover, Opal Frosted, Clear (for use with LED up to 25w/m)</p>	<div style="display: flex; justify-content: space-around;"> <div style="text-align: center;"> <p>Low Square</p>  </div> <div style="text-align: center;"> <p>High Square</p>  </div> <div style="text-align: center;"> <p>Round</p>  </div> </div>
<p>4</p>  <p>19.5mm wide x (other dimensions as drawing) Surface mounted Direct only IP40, IP44 Round, Low & High Square cover, Opal Frosted, Clear Linear Optic 10, 30, 60deg. (for use with LED up to 42w/m)</p>	<div style="display: flex; justify-content: space-around;"> <div style="text-align: center;"> <p>Low Square</p>  </div> <div style="text-align: center;"> <p>High Square</p>  </div> <div style="text-align: center;"> <p>Round</p>  </div> </div>

5



19.5mm wide x (other dimensions as drawing)
Surface mounted Direct only IP40
Round, Low & High Square cover, Opal Frosted, Clear
(for use with LED up to 15w/m)

Low Square

High Square

Round

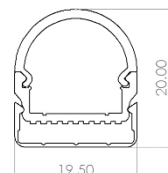
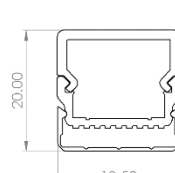
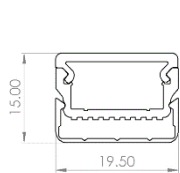

Angled Mounting Profile for Profile 2, 4, 5. Available in 2000mm lengths or 90mm Clips

Low Cover 2, 4, 5

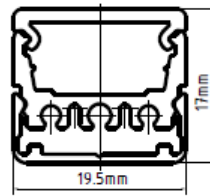
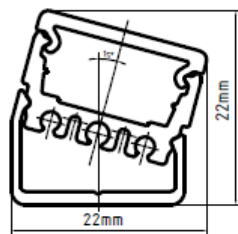
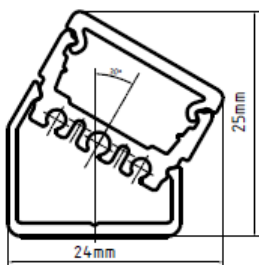
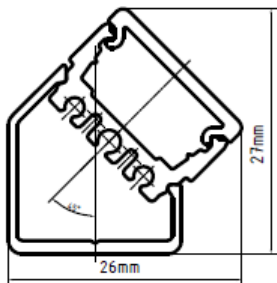

High Square Cover 2, 4, 5

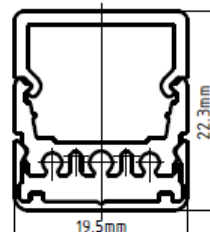
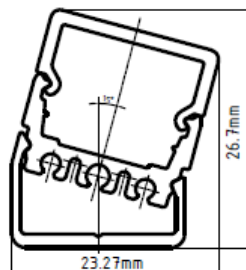
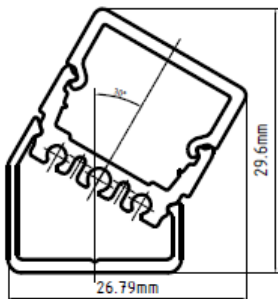
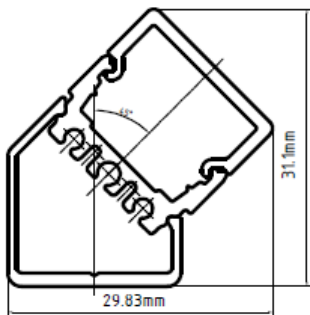

Round Cover 2, 4, 5

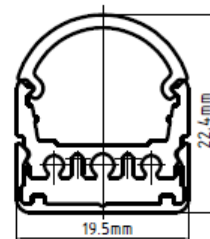
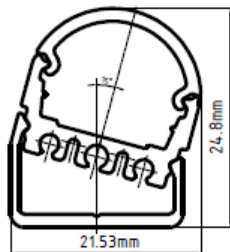
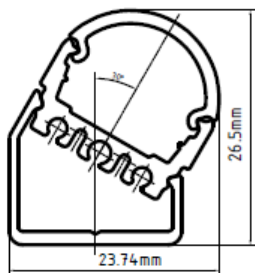
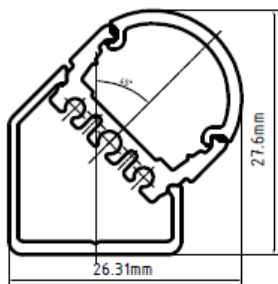

7

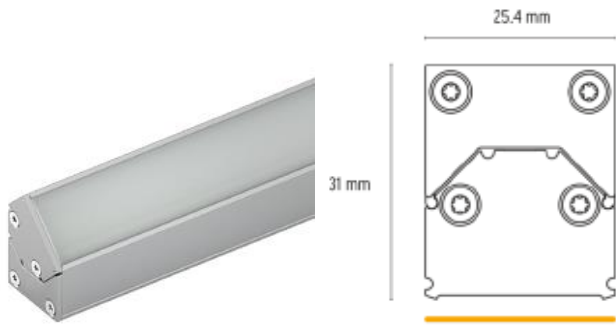

25.4mm x 31mm
 Surface mounted or Suspended, Direct only IP40, IP67
 Low Clear, Frosted, Opal Cover
 (for use with LED up to 36w/m)

7A45

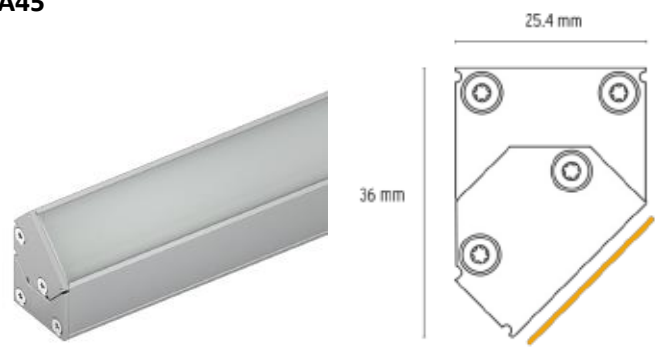

25.4mm x 36mm
 Surface mounted, Direct only IP40, IP67
 Linear Optics Opal or Clear 30 or 60
 (for use with LED up to 36w/m)

SL 7

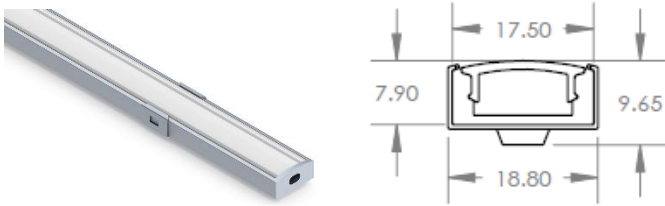

7.9mm(12mm) x 17.5mm
 Surface mounted, Direct only IP40
 Low Opal, Frosted Cover
 (for use with LED up to 15w/m)

SL7 OP

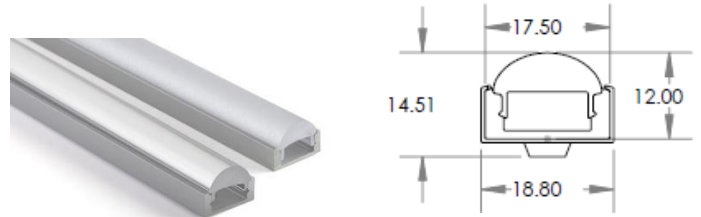

12mm x 17.5mm
 Surface mounted, Direct only IP40
 Linear Optics Opal or Clear 15°, 30° or 60°
 (for use with LED up to 15w/m)

SL 15

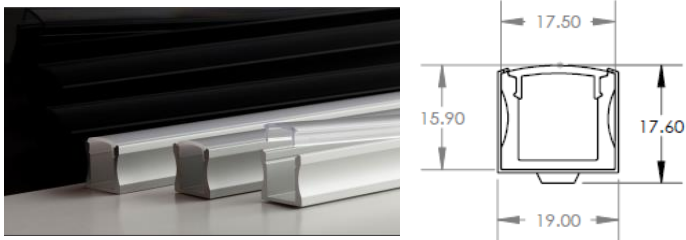

15mm x 17.5mm
 Surface mounted, Direct only IP40
 Low Opal, Frosted Cover, Linear Optic 15°, 30°, 60°
 (for use with LED up to 20w/m)

SL 15 OP

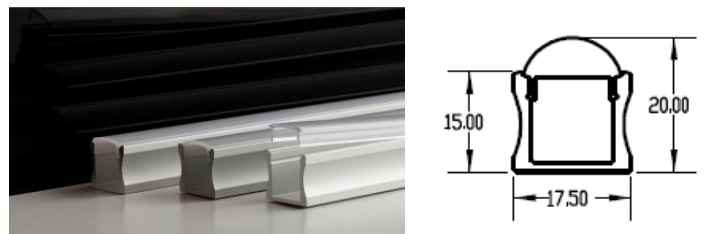

15mm x 17.5mm
 Surface mounted, Direct only IP40
 Low Opal, Frosted Cover, Linear Optic 15°, 30°, 60°
 (for use with LED up to 20w/m)

SL 15 FL

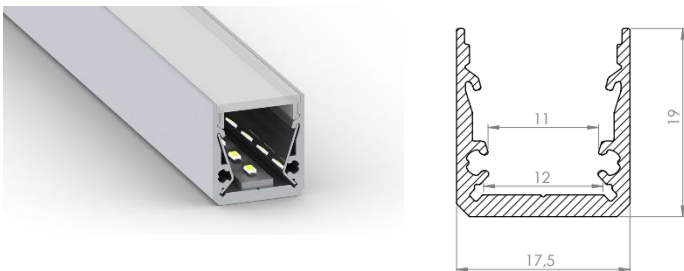

17.5mm x 19mm
 Surface mounted, Direct only, IP40
 Low Opal, Frosted Cover, Linear Optic 15°, 30°, 60°
 (for use with LED up to 25w/m)

SLW 20 FL

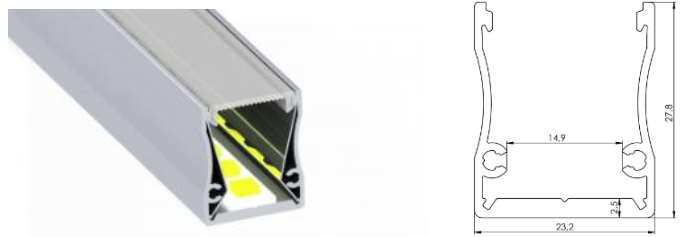

23.2mm x 27.8mm
 Surface mounted, Direct only, IP40
 Low Opal or Frosted Cover
 (for use with LED up to 15w/m)

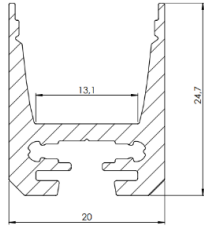
AS 20

20mm x 24.7mm
Surface mounted, Suspended Direct only IP40
Low Opal or Frosted Cover
(for use with LED up to 25w/m)

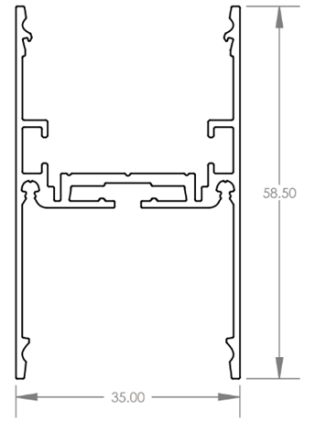
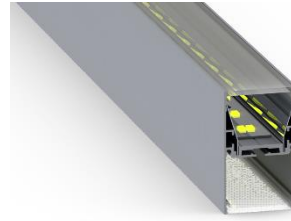
DPL35 FL

38mm x 58.5mm
Suspended Direct/Indirect IP40
Low Opal or Frosted Cover
(for use with LED up to 42w/m)

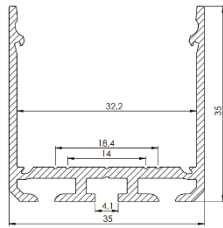
SPL 35 FL

35mm x 35mm
Surface mounted, Suspended Direct only, IP40
Low Opal, Low Frosted or Low Black Light cover
(for use with LED up to 42w/m)

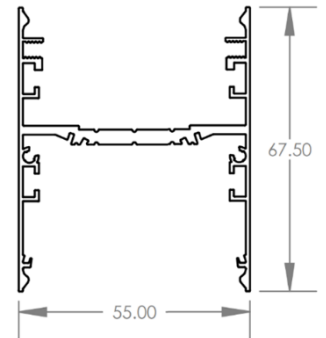
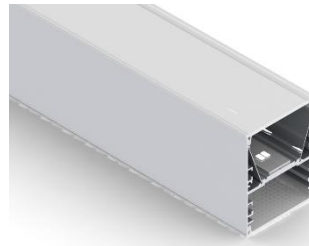
DPL55 FL

55mm x 67.5mm
Suspend Direct/Indirect
Narrow or Wide Beam angle options, IP40
Low Opal or Frosted Cover
(for use with LED up to 42w/m)

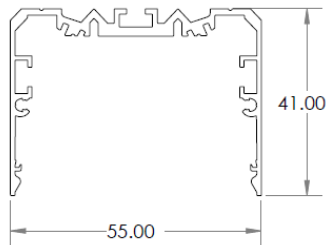
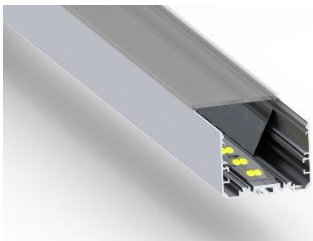
PL55 FL

55mm x 31mm
Surface mounted, Suspended or Recessed Trimless, IP40
Low Opal or Frosted Cover
(for use with LED up to 42w/m)

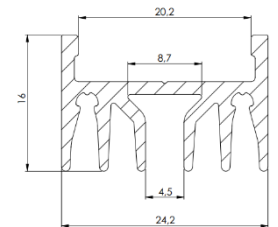
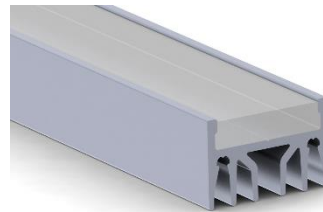
Alu P

16mm x 24mm
Surface mounted, Suspended, Direct only IP40 or IP67
Opal cover
(for use with LED up to 15w/m)

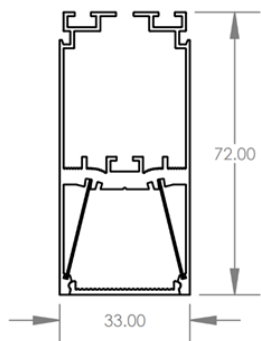
PLS 33

33mm x 72mm
Surface mounted, Suspended, Wall mounted Direct only IP40
Upper housing for integral control gear or wireway
Low Opal or Frosted Cover
(for use with LED up to 42w/m)

024

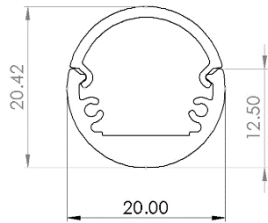

20mm Diameter
Wall bracket or Wire suspended IP40
Round Opal Cover or Linear Optics 15, 30 & 60deg.
(for use with LED up to 15w/m)

Alu R

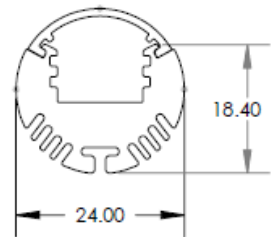

24mm Diameter
End, Arm bracket or Suspended IP40
Round Opal Cover or Linear Optics 30 & 60deg.
(for use with LED up to 15w/m)

AL R 38

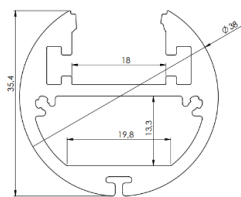

38mm Diameter
End, Arm bracket or Suspended IP40
Round Opal Cover or Linear Optics 30 & 60deg.
(for use with LED up to 42w/m)

8A8

(Only 4mm wide tapes to be used)

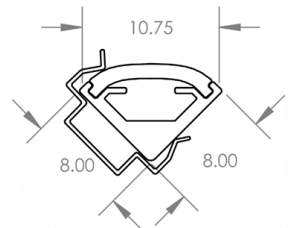
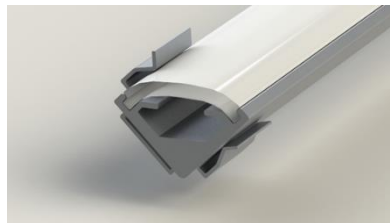

8mm x 8mm angled
Surface mounted, Direct only IP40
Round Opal cover
(for use with LED up to 10w/m)

Alu 45

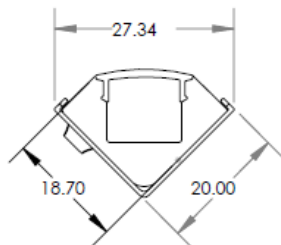

17.6mm x 26mm
Surface mounted, Direct only IP40, IP44
Opal cover
(for use with LED up to 15w/m)

16/16K

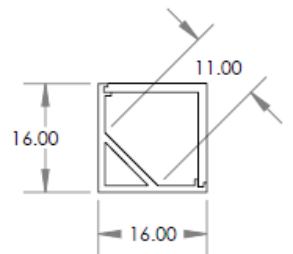
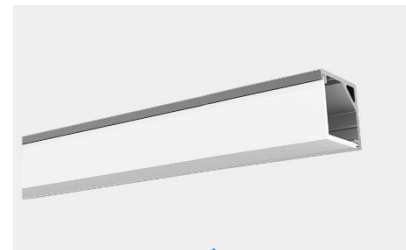

16mm x 16mm
Surface mounted, Direct only
Square Opal Cover
(for use with LED up to 15w/m)

16/16E

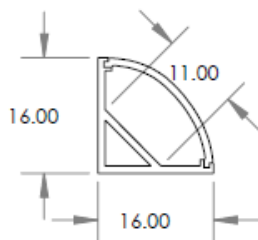
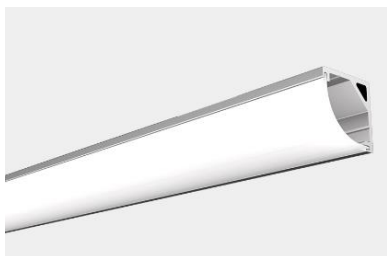

16mm x 16mm
Surface mounted, Direct only
Round Opal Cover
(for use with LED up to 15w/m)

8/9

(Only 4mm wide tapes to be used)

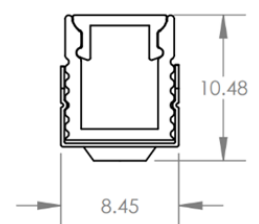
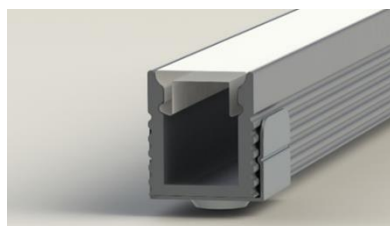

8mm x 9mm
Surface mounted, Direct only IP40
Low Opal cover
(for use with LED up to 10w/m)

6/6

(Only 4mm wide tapes to be used)

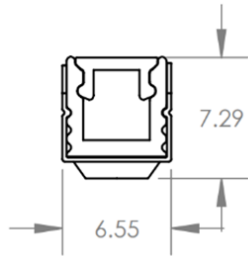
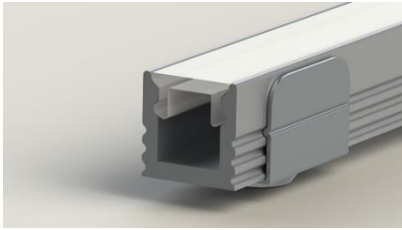

6mm x 6mm
 Surface mounted, Direct only IP40
 Low Opal cover
 (for use with LED up to 10w/m)

Alu Sw

(Only 4mm wide tapes to be used)

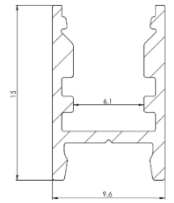

9mm x 15mm

Surface mounted, Direct only IP40
 Low Opal cover
 (for use with LED up to 10w/m)

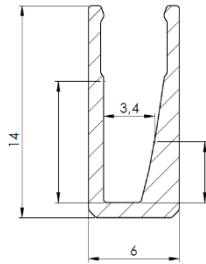
NL 6

6mm x 14mm
 Surface or Recessed in Joinery, Direct only
 Silicon insert to IP67
 (for use with LED up to 10w/m)